

MADE WITH
SWAROVSKI
ELEMENTS

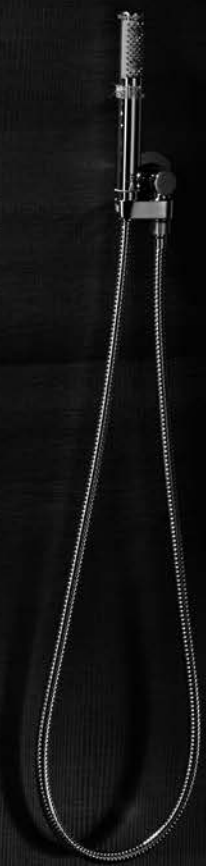

Crystal Line

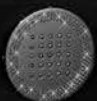
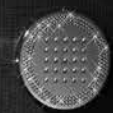

H37456 DREAM - CUBE^{LIGHT} RGB Cromotherapy

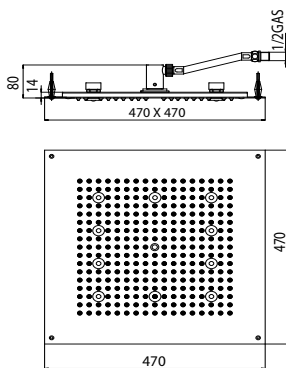
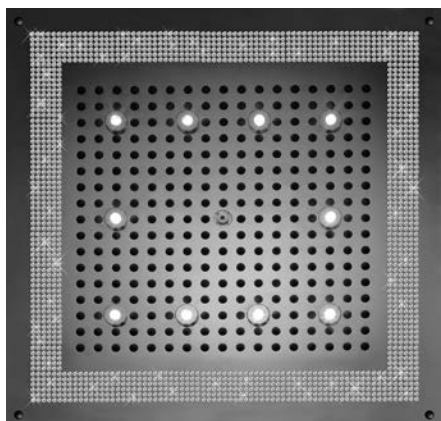

Soffione Dream con luci LED RGB, trasformatore a basso voltaggio, tastiera di controllo per Cromoterapia e flessibile di alimentazione acqua. Installazione a controsoffitto

Dream shower head with RGB LED lights, low voltage transformer, control keyboard for Cromotherapy and flexible water connection. False ceiling installation

Kopfbrause Dream mit RGB LED Lichten, Niederspannungstrafo, Steuertastenfeld für Cromotherapie und Versorgungsschlauch. Montage an der Zwischendecke

Plafond de Douche Dream avec lumières LED RGB, transformateur à bas voltage, clavier de contrôle pour Cromothérapie et flexible pour l'alimentation d'eau. Installation à faux plafond

Rociador Dream con luces LED RGB, transformador de seguridad, teclado de control para Cromoterapia y tubo flexible de alimentación de agua. Instalación falso techo

Душевые лейки Dream со светодиодами LED RGB, трансформатором низкого напряжения, блоком управления для Cromoterapia и гибкой подводкой для подключения к водоснабжению. Установка в подвесной потолок



Packaging Box: 1 pz/pcs
15x55x78



Misura/Size	LED	Finitura/Finish
470 x 470	10	050 cromo/crystal

H37453 DREAM - CUBE^{LIGHT}

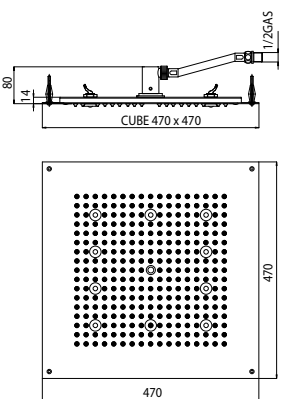
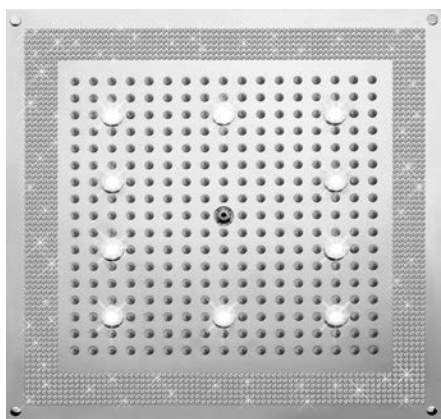

Soffione Dream con luci LED, trasformatore a basso voltaggio, tastiera di controllo e flessibile di alimentazione acqua. Installazione a controsoffitto

Dream shower head with LED lights, low voltage transformer, control keyboard and flexible water connection. False ceiling installation

Kopfbrause Dream mit LED Lichten, Niederspannungstrafo, Steuertastenfeld und Versorgungsschlauch. Montage an der Zwischendecke

Plafond de Douche Dream avec lumières LED, transformateur à bas voltage, clavier de contrôle et flexible pour l'alimentation d'eau. Installation à faux plafond

Rociador Dream con luces LED, transformador de seguridad, teclado de control y tubo flexible de alimentación de agua. Instalación falso techo

Душевые лейки Dream со светодиодами LED, трансформатором низкого напряжения, блоком управления и гибкой подводкой для подключения к водоснабжению. Установка в подвесной потолок



Packaging Box: 1 pz/pcs
15x55x78



Misura/Size	LED	Finitura/Finish
470 x 470	10	050 cromo/crystal

H38459 DREAM - CUBE

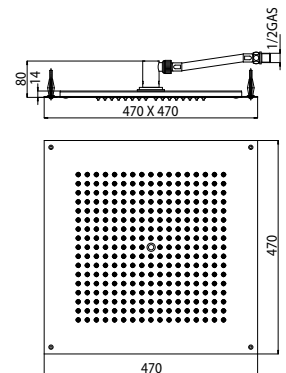
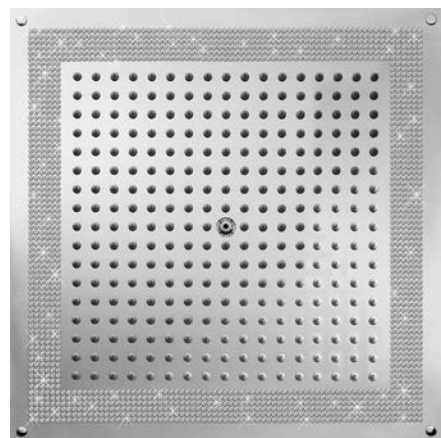

Soffione Dream da controsoffitto, con flessibile di alimentazione acqua

Dream shower head for false ceiling, with flexible water connection

Kopfbrause Dream mit Versorgungsschlauch. Montage an der Zwischendecke

Plafond de douche Dream avec flexible pour l'alimentation d'eau. Installation à faux plafond

Rociador Dream con tubo flexible de alimentación de agua. Instalación falso techo

Душевые лейки Dream для установки в подвесной потолок, в комплекте с гибкой подводкой для подключения к водоснабжению

Packaging Box: 1 pz/pcs
15x55x78



Misura/Size	Finitura/Finish
470 x 470	050 cromo/crystal

H37457 DREAM - OKI^{LIGHT} RGB Cromotherapy

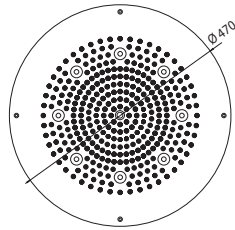
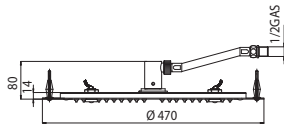
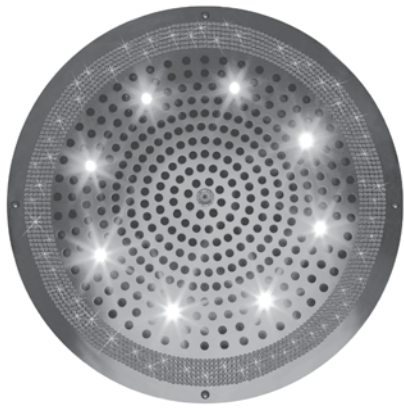

Packaging Box: 1 pz/pcs
15x55x78



Soffione Dream con luci LED RGB, trasformatore a basso voltaggio, tastiera di controllo per Cromoterapia e flessibile di alimentazione acqua. Installazione a controsoffitto

Dream shower head with RGB LED lights, low voltage transformer, control keyboard for Cromotherapy and flexible water connection. False ceiling installation

Kopfbrause Dream mit RGB LED Lichten, Niederspannungstrafo, Steuertastenfeld für Cromotherapie und Versorgungsschlauch. Montage an der Zwischendecke

Plafond de Douche Dream avec lumières LED RGB, transformateur à bas voltage, clavier de contrôle pour Cromothérapie et flexible pour l'alimentation d'eau. Installation à faux plafond

Rociador Dream con luces LED RGB, transformador de seguridad, teclado de control para Cromoterapia y tubo flexible de alimentación de agua. Instalación falso techo

Душевые лейки Dream со светодиодами LED RGB, трансформатором низкого напряжения, блоком управления для Cromoterapia и гибкой подводкой для подключения к водоснабжению. Установка в подвесной потолок

Misura/Size	LED	Finitura/Finish
Ø 470	8	050 cromo/crystal

H37454 DREAM - OKI^{LIGHT}

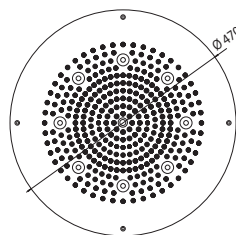
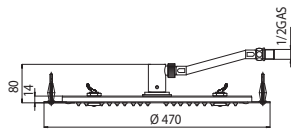

Packaging Box: 1 pz/pcs
15x55x78



Soffione Dream con luci LED, trasformatore a basso voltaggio, tastiera di controllo e flessibile di alimentazione acqua. Installazione a controsoffitto

Dream shower head with LED lights, low voltage transformer, control keyboard and flexible water connection. False ceiling installation

Kopfbrause Dream mit LED Lichten, Niederspannungstrafo, Steuertastenfeld und Versorgungsschlauch. Montage an der Zwischendecke

Plafond de Douche Dream avec lumières LED, transformateur à bas voltage, clavier de contrôle et flexible pour l'alimentation d'eau. Installation à faux plafond

Rociador Dream con luces LED, transformador de seguridad, teclado de control y tubo flexible de alimentación de agua. Instalación falso techo

Душевые лейки Dream со светодиодами LED, трансформатором низкого напряжения, блоком управления и гибкой подводкой для подключения к водоснабжению. Установка в подвесной потолок

Misura/Size	LED	Finitura/Finish
Ø 470	8	050 cromo/crystal

H38458 DREAM - OKI

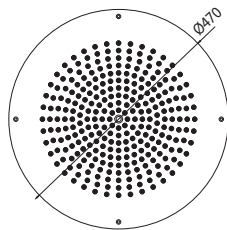
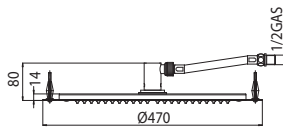

Soffione Dream da controsoffitto, con flessibile di alimentazione acqua

Dream shower head for false ceiling, with flexible water connection

Kopfbrause Dream mit Versorgungsschlauch. Montage an der Zwischendecke

Plafond de douche Dream avec flexible pour l'alimentation d'eau. Installation à faux plafond

Rociador Dream con tubo flexible de alimentación de agua. Instalación falso techo

Душевые лейки Dream для установки в подвесной потолок, в комплекте с гибкой подводкой для подключения к водоснабжению

Packaging Box: 1 pz/pcs
15x55x78



Misura/Size	Finitura/Finish
Ø 470	050 cromo/crystal



SW

H80166 DINAMIC Ø 140

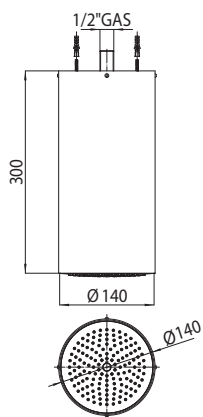

Soffione Dinamic-Inox Ø 140 mm H 300 mm con rivestimento in acciaio inox. Installazione a soffitto

Dinamic-Inox shower head Ø 140 mm H 300 mm with stainless steel cover. Ceiling Installation

Kopfbräuse Dinamic-Inox aus Edelstahl Ø 140 mm H 300 mit selbstreinigendem Strahl. Montage an der Decke

Plafond de douche Dinamic-Inox Ø 140 mm H 300 avec couverture en inox. Installation au plafond

Rociador Dinamic-Inox Ø 140 mm H 300 revestido de acero inoxidable. Instalación techo

Душевая лейка Dinamic-Inox Ø 140 mm H 300 с плафоном из стали inox. Потолочная установка

Packaging Box: 1 pz/pcs
19,5x19,5x39



Misura / Size

Finitura / Finish

Ø 140

050 cromo/crystal

I00175 TONDO FLAT

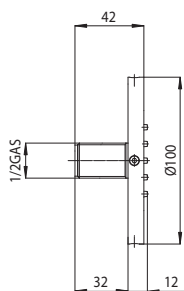

Soffione laterale in ottone, getto pioggia autopulente. Installazione a muro

Rain function brass body spray – Easy-Clean spray pattern. Wall installation

Seitenbräuse aus Messing mit selbstreinigendem Regenstrahl. Montage an der Wand

Body jet latéral laiton jet pluie autonettoyant. Installation au mur

Ducha lateral latón chorro lluvia autolimpiante. Instalación pared

Форсунка боковая, струя «дождь» самоочищающаяся из латуни. Настенная установка

Packaging Box: 40 pz/pcs
35x35x50



Misura / Size mm

Finitura / Finish

Ø 100 - 1/2" M GAS

050 cromo/crystal

I00176 CUBIC-FLAT

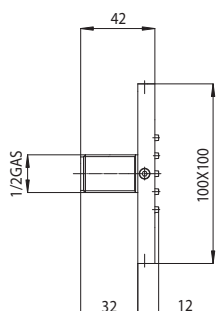
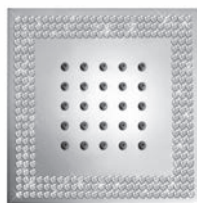

Soffione laterale in ottone, getto pioggia autopulente. Installazione a muro

Rain function brass body spray - Easy-Clean spray pattern. Wall installation

Seitenbräuse aus Messing mit selbstreinigendem Regenstrahl. Montage an der Wand

Body jet latéral laiton jet pluie autonettoyant. Installation au mur

Ducha lateral latón chorro lluvia autolimpiante. Instalación pared

Форсунка боковая, струя «дождь» самоочищающаяся из латуни. Настенная установка

Packaging Box: 40 pz/pcs
35x35x50



Misura / Size mm

Finitura / Finish

100x100 - 1/2" M GAS

050 cromo/crystal

B00270 FLAT ONE

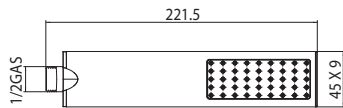

Packaging Box: x 90 pz/pcs
25x35x40



Doccia monogetto in ottone
Single function brass handshower
Handbrause aus Messing mit Regenstrahl
Douchette laiton jet pluie
Mango ducha latón chorro lluvia
Душевая лейка из латуни моноструя

Finitura/Finish

050 cromo/crystal

C13001 FLAT ONE

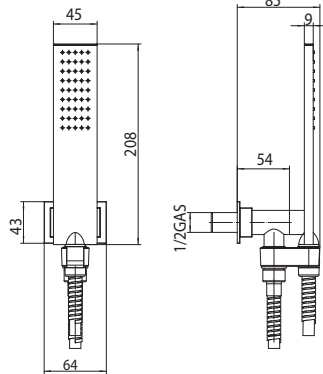

Packaging Box: 20 pz/pcs
40x40x60



Duplex doccia Flat One con supporto ad incasso, attacco conico girevole e flessibile in ottone cm 150
Flat One shower set with supply elbow and swivel hook, brass hose 150 cm
Brauseset Flat One mit Wandanschlussbogen, schwenkbarem Brausehalter und Messing Schlauch cm 150
Ensemble de douche Flat One avec sortie murale à support orientable et flexible laiton cm 150
Conjunto de ducha Flat one con toma agua, soporte orientable y flexible de latón cm 150
Комплект душевой лейки Flat One и встраиваемого держателя с поворотным конусообразным соединением и шлангом из латуни 150 см

Finitura/Finish

050 cromo/crystal

B00250 ZEN

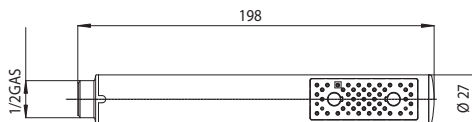

Packaging Box: x 90 pz/pcs
25x35x40



Doccia monogetto in ottone
Single function brass handshower
Handbrause aus Messing mit Regenstrahl
Douchette laiton jet pluie
Mango ducha latón chorro lluvia
Душевая лейка из латуни моноструя

Finitura/Finish

050 cromo/crystal

C54001 ZEN

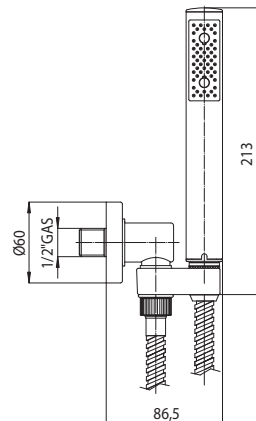

Packaging Box: x 20 pz/pcs
40x40x60



Duplex doccia Zen con supporto incasso attacco conico girevole e flessibile ottone doppia aggiratura cm 150
Zen shower set with supply elbow w/shower hook and double interlock brass hose 150 cm
Brauseset Zen, Brausehalter mit Wandanschluss und Doppelwicklung Brauseschlauch cm 150
Ensemble de douche Zen avec sortie murale avec support orientable et flexible laiton double agrafage cm 150
Conjunto de ducha Zen con soporte orientable con toma de agua y flexible de latón doble grapado cm 150
Комплект лейка Zen с встроенным поворотным держателем и шлангом дв. фальцевания из латуни 150 см

Finitura/Finish

050 cromo/crystal



SW



Z030201000



Miscelatori Termostatici Alta Portata - 2 USCITE / OUTLETS

Parti incasso per miscelatore termostatico alta portata attacchi da 3/4", installazione verticale/ orizzontale a **2 USCITE**

*Concealed High Flow Thermostatic Mixer, 3/4" connections, vertical/horizontal installation with **2 OUTLETS** (2 stop valves)*

*Unterputz-Einbaukörper für Thermostat-Mischbatterie mit hohem Durchfluss, 3/4" Anschlüsse, Einbau vertikal oder horizontal mit **2 AUSGÄNGEN***

*Parties à encastrer pour mitigeur thermostatique haut débit, raccords 3/4", installation verticale/ horizontale à **2 SORTIES***

*Partes de empotrado para mezcladora termostática de flujo alto con conexiones de 3/4", instalación vertical/horizontal con **2 SALIDAS***

*Детали наружные, для термостатического смесителя высокой пропускной способности на 3/4", установка вертикальная/горизонтальная **2 ВЫХОДА***

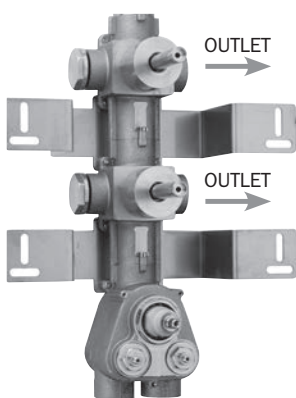

PIASTRA INTERA - SINGLE BACK PLATE

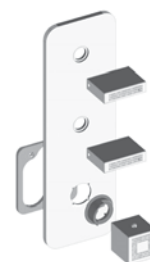
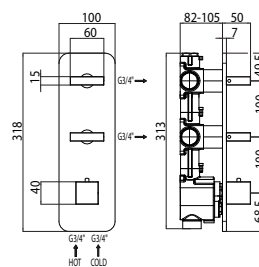

PIASTRE INDIVIDUALI - INDIVIDUAL PLATES

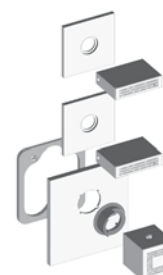
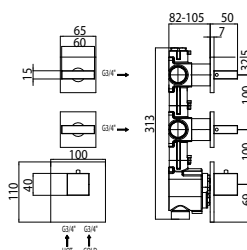

Codice/Code

Uscite/Outlets

Z030201000

2

Packaging Box: 1 pz/pcs
27,5x17,5x51



Codice/Code	Uscite/Outlets	Finitura/Finish
Z031204	2	050 cromo/crystal

Packaging Box: 1 pz/pcs
6,5x20,5x49

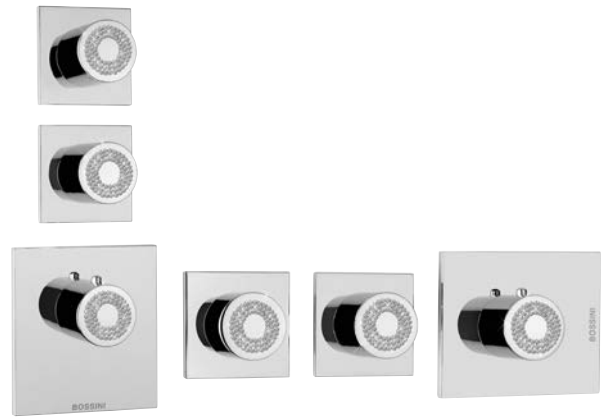

Codice/Code	Uscite/Outlets	Finitura/Finish
Z031203	2	050 cromo/crystal

Packaging Box: 1 pz/pcs
26x6x27



Codice/Code	Uscite/Outlets	Finitura/Finish
Z033204	2	050 cromo/crystal

Packaging Box: 1 pz/pcs
6,5x20,5x49

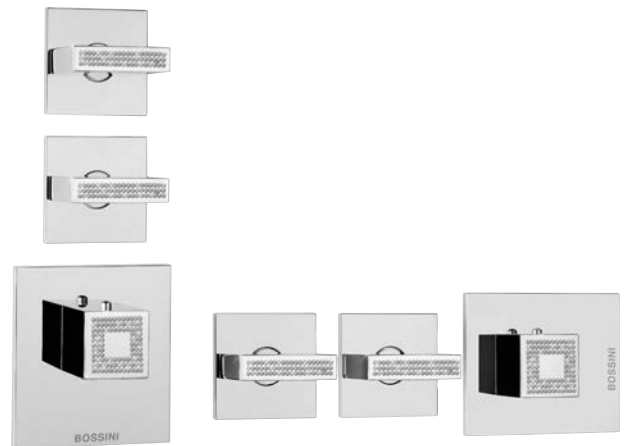

Codice/Code	Uscite/Outlets	Finitura/Finish
Z033203	2	050 cromo/crystal

Packaging Box: 1 pz/pcs
26x6x27



SW

PIASTRA INTERA - SINGLE BACK PLATE

Parti esterne **2 USCITE** con piastra intera installazione verticale/orizzontale per miscelatore termostatico (Z030201 000)

*External parts for vertical / horizontal installation with **2 OUTLETS** and single back plate for Thermostatic Mixer (Z030201 000)*

*Aufputzteile **2 AUSGÄNGE** mit Vollplatte, Einbau vertikal oder horizontal, für Thermostat-Mischbatterie (Z030201 000)*

*Parties externes **2 SORTIES** avec plaque multi-éléments, installation verticale/horizontale pour mitigeur thermostatique (Z030201 000)*

*Partes externas **2 SALIDAS** con placa completa, instalación vertical/horizontal para mezcladora termostática (Z030201 000)*

*Детали наружные, **2 ВЫХОДА** с цельной панелью, установка вертикальная/горизонтальная для термостатического смесителя (Z030201 000)*

PIASTRE INDIVIDUALI - INDIVIDUAL PLATES

Parti esterne **2 USCITE** con piastre individuali installazione verticale/orizzontale per miscelatore termostatico (Z030201 000)

*External parts for vertical/horizontal installation with **2 OUTLETS** and individual plates for Thermostatic Mixer (Z030201 000)*

*Aufputzteile **2 AUSGÄNGE** mit Einzelplatten, Einbau vertikal oder horizontal, für Thermostat-Mischbatterie (Z030201 000)*

*Parties externes **2 SORTIES** avec plaques individuelles, installation verticale/horizontale pour mitigeur thermostatique (Z030201 000)*

*Partes externas **2 SALIDAS** con placas individuales, instalación vertical/horizontal para válvula termostática (Z030201 000)*

*Детали наружные **2 ВЫХОДА** с отдельными панелями, установка вертикальная/горизонтальная для термостатического смесителя (Z030201 000)*



Z030203000



Miscelatori Termostatici Alta Portata - 3 USCITE / OUTLETS

Parti incasso per miscelatore termostatico alta portata attacchi da 3/4" a **3 USCITE** (c/deviatore 2 vie e un rubinetto d'arresto), installazione verticale/ orizzontale

Concealed parts for High Flow Thermostatic Mixer, 3/4" connections, with **3 OUTLETS** (2 way diverter valve and 1 stop valve) vertical /horizontal installation

Unterputz-Einbaukörper für Thermostat-Mischbatterie mit hohem Durchfluss, 3/4" Anschlüsse, **3 AUSGÄNGE** (2-Wege-Umstellventil und ein Absperrventil), Einbau vertikal oder horizontal

Parties à encastrer pour mitigeur thermostatique haut débit, raccords 3/4" à **3 SORTIES** (inverseur 2 voies et un robinet d'arrêt), installation verticale/ horizontale

Partes de empotrado para mezcladora termostática de flujo alto con conexiones de 3/4", con **3 SALIDAS** (con desviador de 2 vías y un grifo de cierre), instalación vertical/horizontal

Детали, встроенного монтажа, для термостатического смесителя, высокой пропускной способности на 3/4", на **3 ВЫХОДА** (С ДЕВИАТОРОМ 2 НАПРАВЛЕНИЯ и запорным вентилем), установка вертикальная/ горизонтальная

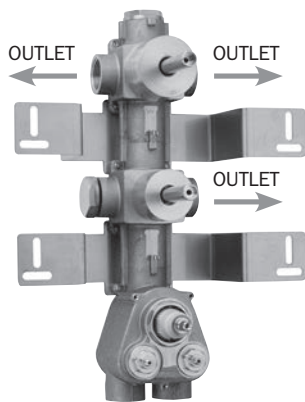

PIASTRA INTERA - SINGLE BACK PLATE

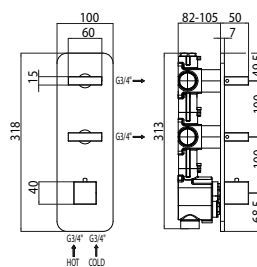

PIASTRE INDIVIDUALI - INDIVIDUAL PLATES

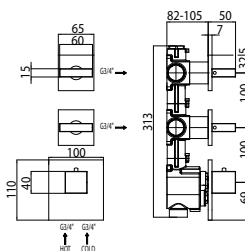

Codice/Code Uscite/Outlets

Z030203000

3

Packaging Box: 1 pz/pcs
27,5x17,5x51



Codice/Code	Uscite/Outlets	Finitura/Finish
Z031204	3	050 cromo/crystal

Packaging Box: 1 pz/pcs
6,5x20,5x49

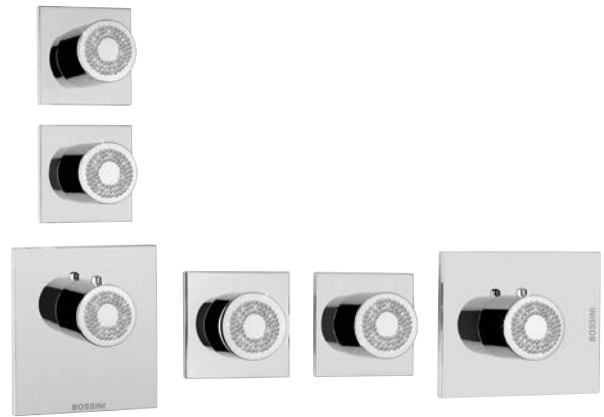

Codice/Code	Uscite/Outlets	Finitura/Finish
Z031203	3	050 cromo/crystal

Packaging Box: 1 pz/pcs
26x6x27



Codice/Code	Uscite/Outlets	Finitura/Finish
Z033204	3	050 cromo/crystal

Packaging Box: 1 pz/pcs
6,5x20,5x49

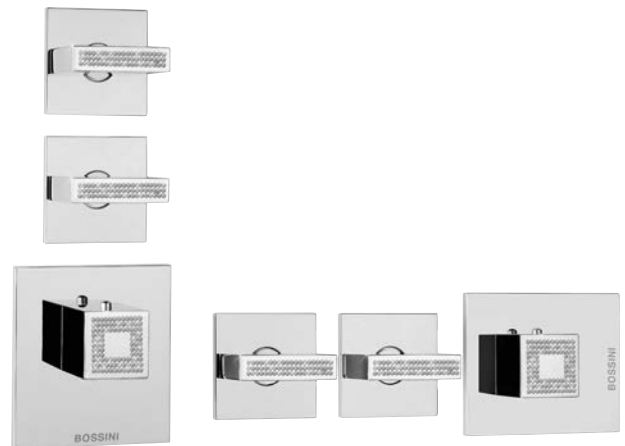

Codice/Code	Uscite/Outlets	Finitura/Finish
Z033203	3	050 cromo/crystal

Packaging Box: 1 pz/pcs
26x6x27



SW

PIASTRA INTERA - SINGLE BACK PLATE

Parti esterne **3 USCITE** con piastra intera installazione verticale/orizzontale per miscelatore termostatico (Z030203 000)

External parts for vertical / horizontal installation with **3 OUTLETS** and single back plate for Thermostatic Mixer (Z030203 000)

Aufputzteile **3 AUSGÄNGE** mit Vollplatte, Einbau vertikal oder horizontal, für Thermostat-Mischbatterie (Z030203 000)

Parties externes **3 SORTIES** avec plaque multi-éléments, installation verticale/horizontale pour mitigeur thermostatique (Z030203 000)

Partes externas **3 SALIDAS** con placa completa, instalación vertical/horizontal para mezcladora termostática (Z030203 000)

Детали наружные, **3 ВЫХОДА** с цельной панелью, установка вертикальная/горизонтальная для термостатического смесителя (Z030203 000)

PIASTRE INDIVIDUALI - INDIVIDUAL PLATES

Parti esterne **3 USCITE** con piastre individuali, installazione verticale/orizzontale per miscelatore termostatico (Z030203 000)

External parts for vertical/horizontal installation with **3 OUTLETS** and individual plates for Thermostatic Mixer (Z030203 000)

Aufputzteile **3 AUSGÄNGE** mit Einzelplatten, Einbau vertikal oder horizontal, für Thermostat-Mischbatterie (Z030203 000)

Parties externes **3 SORTIES** avec plaques individuelles, installation verticale/horizontale pour mitigeur thermostatique (Z030203 000)

Partes externas **3 SALIDAS** con placas individuales, instalación vertical/horizontal para mezcladora termostática (Z030203 000)

Детали наружные **3 ВЫХОДА** с отдельными панелями, установка вертикальная/горизонтальная для термостатического смесителя (Z030203 000)



Z030202000

LP

Miscelatori Termostatici Alta Portata - 3 USCITE / OUTLETS

Parti incasso per miscelatore termostatico alta portata attacchi da 3/4", installazione verticale/ orizzontale a **3 USCITE**

Concealed parts for High Flow Thermostatic Mixer, 3/4" connections, vertical/horizontal installation with **3 OUTLETS** (3 stop valves)

Unterputz-Einbaukörper für Thermostat-Mischbatterie mit hohem Durchfluss, 3/4" Anschlüsse, Einbau vertikal oder horizontal, **3 AUSGÄNGE**

Parties à encastrer pour mitigeur thermostatique haut débit, raccords 3/4", installation verticale/horizontale à **3 SORTIES**

Partes de empotrado para mezcladora termostática de flujo alto con conexiones de 3/4", instalación vertical/horizontal con **3 SALIDAS**

Детали, встроенного монтажа, для термостатического смесителя, высокой пропускной способности на 3/4", установка вертикальная/ горизонтальная на **3 ВЫХОДА**

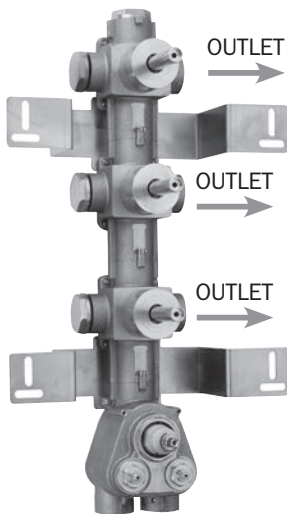

PIASTRE INDIVIDUALI - INDIVIDUAL PLATES

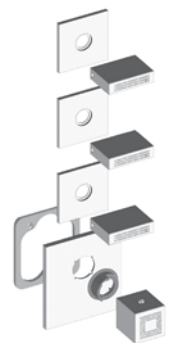
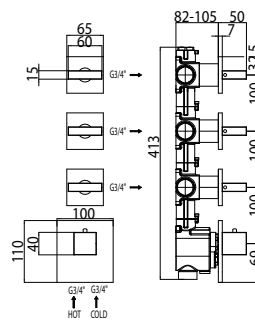

Codice/Code Uscite/Outlets

Z030202000

3

Packaging Box: 1 pz/pcs
27,5x17,5x51

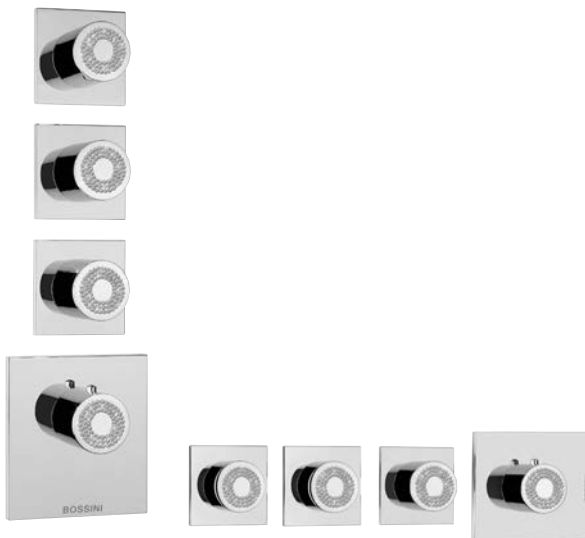

Codice/Code	Uscite/Outlets	Finitura/Finish
Z031205	3	050 cromo/crystal

Packaging Box: 1 pz/pcs
26x6x27

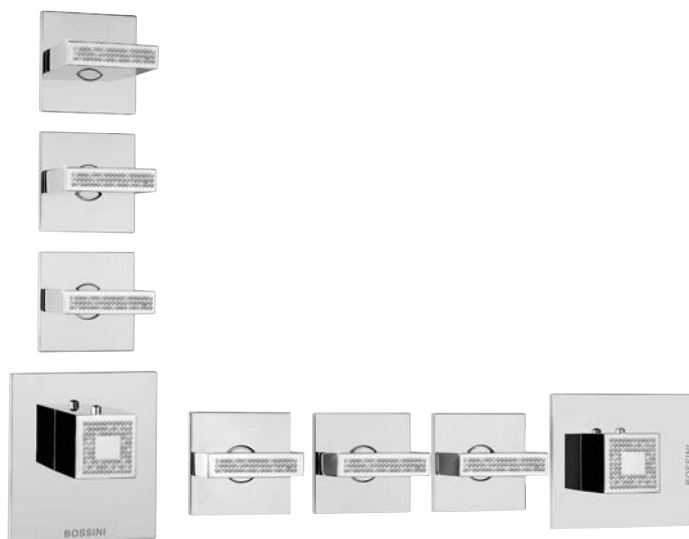

Codice/Code	Uscite/Outlets	Finitura/Finish
Z033205	3	050 cromo/crystal

Packaging Box: 1 pz/pcs
26x6x27



SW

PIASTRE INDIVIDUALI - INDIVIDUAL PLATES

Parti esterne **3 USCITE** con piastre individuali installazione verticale/orizzontale per miscelatore termostatico (Z030202 000)
 External parts for vertical/horizontal installation with **3 OUTLETS** and individual plates for Thermostatic Mixer (Z030202 000)
 Aufputzteile **3 AUSGÄNGE** mit Einzelplatten, Einbau vertikal oder horizontal, für Thermostat-Mischbatterie (Z030202 000)
 Parties externes **3 SORTIES** avec plaques individuelles, installation verticale/horizontale pour mitigeur thermostatique (Z030202 000)
 Partes externas **3 SALIDAS** con placas individuales, instalación vertical/horizontal para válvula termostática (Z030202 000)
 Детали наружные **3 ВЫХОДА** с отдельными панелями, установка вертикальная/горизонтальная для термостатического смесителя (Z030202 000)